

CATALOGUE 2020

# RF Adapter

Use this adapter to connect components of  
the radio frequency technology together.

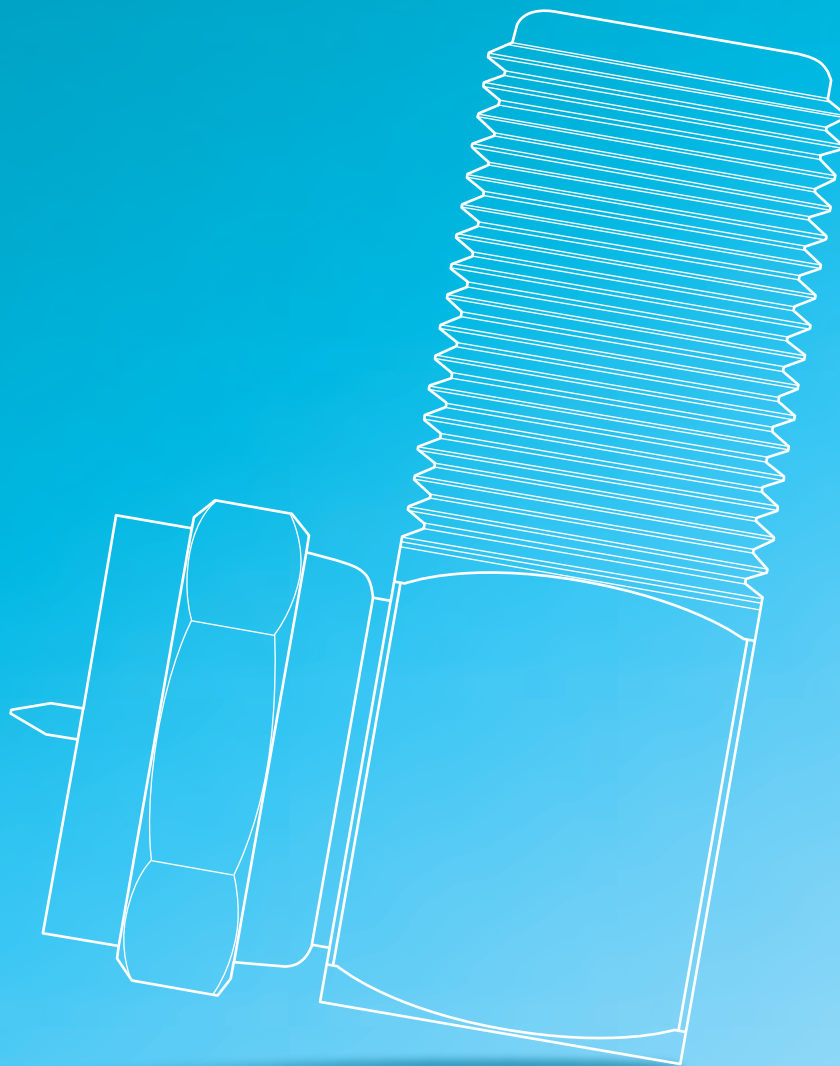

# RF Adapter

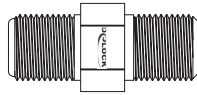



**03**  **88411**  
Adapter RP-SMA jack >  
RP-TNC plug

**04**  **88478**  
Adapter SMA jack >  
SMA jack

**05**  **88568**  
Adapter SMA jack >  
BNC jack

**06**  **88723**  
Adapter SMA plug >  
SMA jack

**07**  **88726**  
Adapter SMA plug >  
SMA plug

**08**  **88727**  
Adapter RP-SMA plug >  
SMA plug

**09**  **88728**  
Adapter RP-SMA plug >  
SMA jack

**10**  **88734**  
Adapter RP-SMA jack >  
SMA plug

**11**  **88736**  
Adapter RP-SMA jack >  
SMA jack

**12**  **88779**  
Adapter SMA jack >  
SMA jack bulkhead

**13**  **88794**  
Adapter N plug >  
N plug

**14**  **88795**  
Adapter N plug >  
F jack

**15**  **88796**  
Adapter N plug >  
TNC jack

**16**  **88803**  
Adapter N jack >  
N jack bulkhead

**17**  **88805**  
Adapter FME plug >  
SMB plug

**18**  **88819**  
Adapter RP-SMA plug >  
RP-TNC jack

**19**  **88826**  
Adapter RP-SMA plug >  
SMA plug 90°

**20**  **88827**  
Adapter N plug >  
TNC plug

**21**  **88828**  
Adapter SMA jack >  
SMB jack

**22**  **88829**  
Adapter SMA jack >  
SMB plug

**23**  **88830**  
Adapter SMA plug >  
SMB jack

**24**  **88831**  
Adapter N plug >  
SMA plug

**25**  **88832**  
Adapter N jack >  
SMA jack

**26**  **88837**  
Adapter N jack >  
SMA plug

**27**  **88838**  
Adapter N plug >  
SMA jack

**28**  **88839**  
Adapter N jack >  
BNC jack bulkhead

**29**  **88840**  
Adapter N plug >  
7/16 jack

**30**  **88842**  
Adapter N jack >  
BNC jack

**31**  **88847**  
Adapter N jack >  
RP-SMA plug bulkhead

**32**  **88848**  
Adapter N jack >  
RP-SMA plug

**33**  **88850**  
Adapter N plug >  
RP-SMA jack

**34**  **88851**  
Adapter RP-TNC jack >  
SMA jack

# RF Adapter

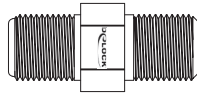

**35**  **88853**  
Adapter RP-TNC plug >  
SMA plug

**36**  **88854**  
Adapter N plug >  
RP-TNC jack

**37**  **88855**  
Adapter N jack >  
RP-TNC plug

**38**  **88856**  
Adapter N jack >  
RP-TNC jack

**39**  **88857**  
Adapter N plug >  
RP-TNC plug

**40**  **88859**  
Adapter MCX plug >  
N plug

**41**  **88868**  
Adapter N jack >  
SMB jack

**42**  **88869**  
Adapter N plug >  
SMB plug

**43**  **88870**  
Adapter N jack >  
SMB plug

**44**  **88871**  
Adapter N plug >  
SMB jack

**45**  **88872**  
Adapter N jack >  
SMA jack bulkhead

**46**  **88875**  
Adapter RP-SMA plug metric thread >  
RP-SMA jack

**47**  **88880**  
Adapter F jack >  
F plug 90°

**48**  **88881**  
Adapter F jack >  
F jack > F jack T-Shape

**49**  **88882**  
Adapter F jack >  
F jack

**50**  **88883**  
Adapter F plug >  
F plug

**51**  **88887**  
Adapter SMA plug >  
SMA plug 90°

**52**  **88905**  
Adapter SMA jack >  
SMA jack > SMA jack T-Shape

**53**  **89573**  
Adapter N jack >  
TNC plug

# Adapter RP-SMA jack > RP-TNC plug



CE

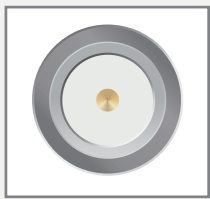

① RP-SMA jack

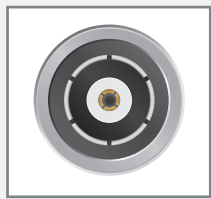

② RP-TNC plug

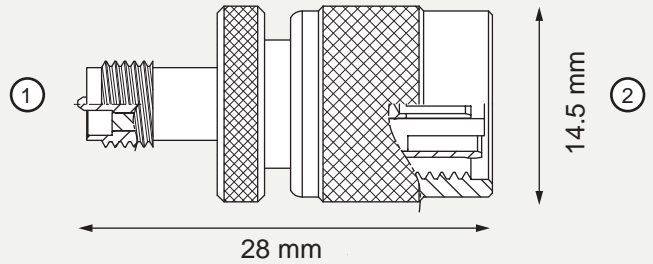

Housing material  
Nickel plated brass



Length  
28 mm



Impedance  
50 Ω

# Adapter SMA jack > SMA jack



CE

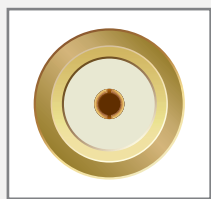

① SMA jack

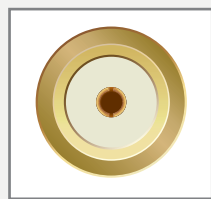

② SMA jack

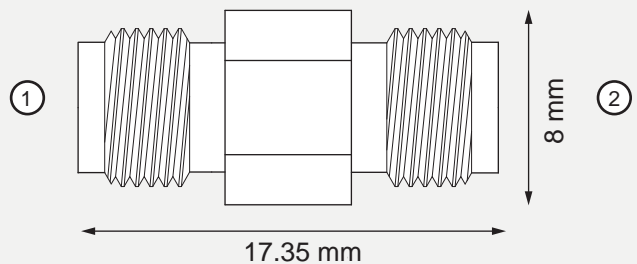

Housing material  
Gold plated brass



Length  
17.35 mm



diameter  
8 mm



Impedance  
50 Ω

# Adapter SMA jack > BNC jack



CE

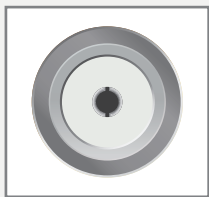

① SMA jack

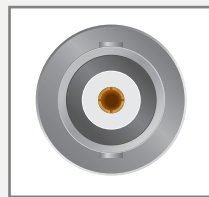

② BNC jack

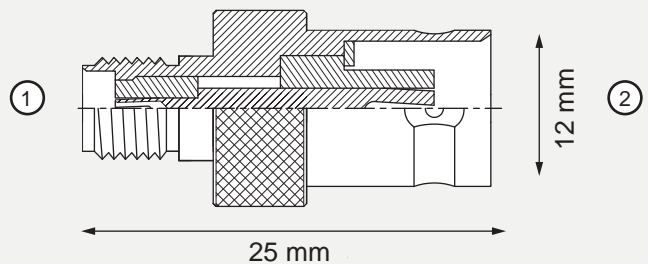

Housing material  
Nickel plated brass



Dimension  
25 x 12 mm



Impedance  
50 Ω

# Delock Adapter SMA plug > SMA jack



CE

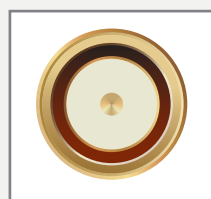

① SMA plug

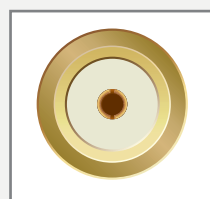

② SMA jack

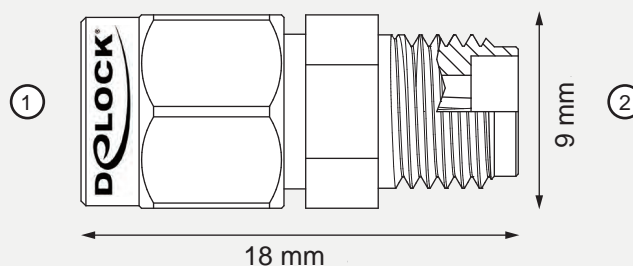

Housing material  
Gold plated brass



Length  
18 mm



diameter  
HEX 8 mm  
max. 9 mm



Impedance  
50 Ω

# Adapter SMA plug > SMA plug



CE

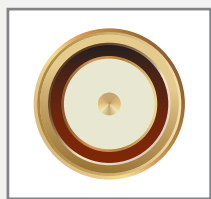

① SMA plug

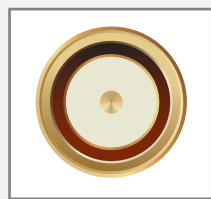

② SMA plug

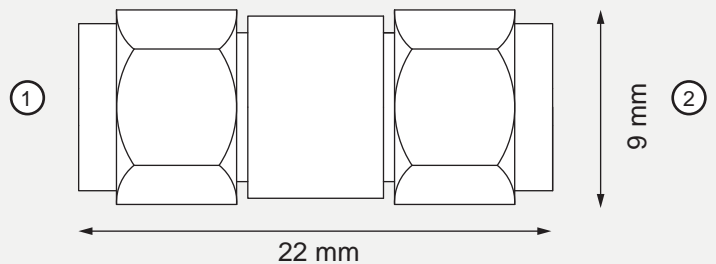

Housing material  
Gold plated brass



Length  
22 mm



diameter  
HEX 8 mm  
max. 9 mm



Impedance  
50 Ω



# Adapter RP-SMA plug > SMA plug

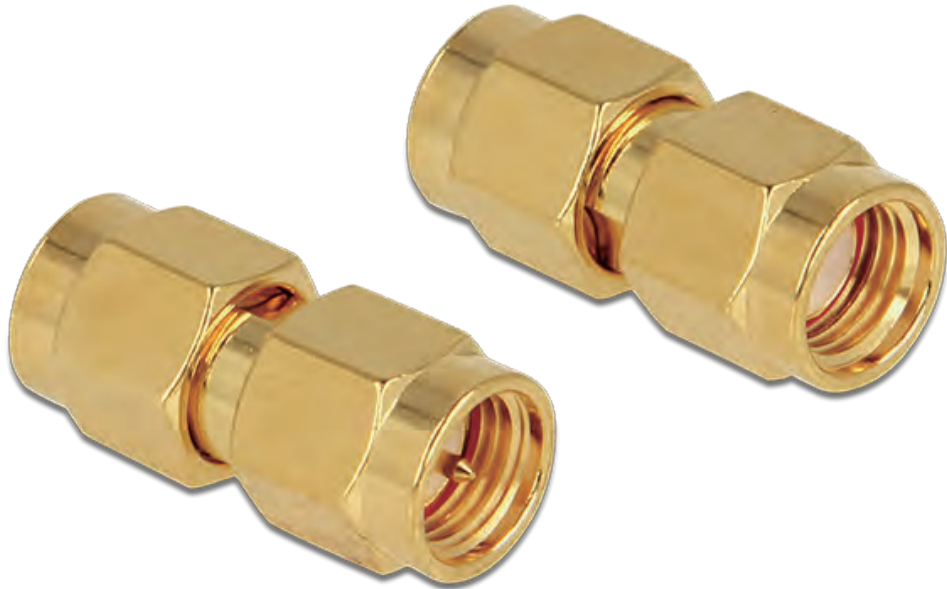

CE

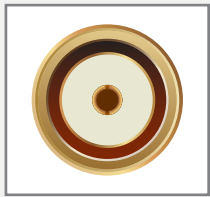

① PR-SMA plug

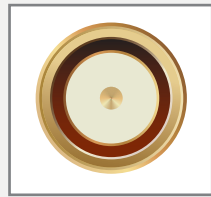

② SMA plug

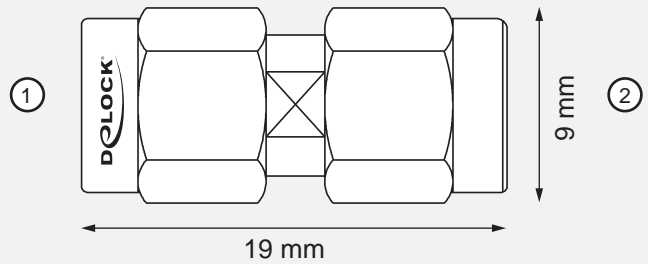

Housing material  
Gold plated brass



Length  
19 mm



diameter  
HEX 8 mm  
max. 9 mm



Impedance  
50 Ω

# Adapter RP-SMA plug > SMA jack



CE

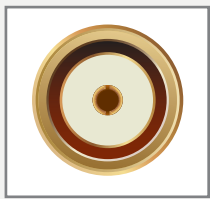

① RP-SMA plug

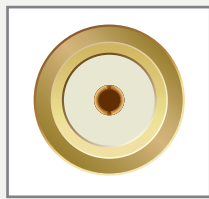

② SMA jack

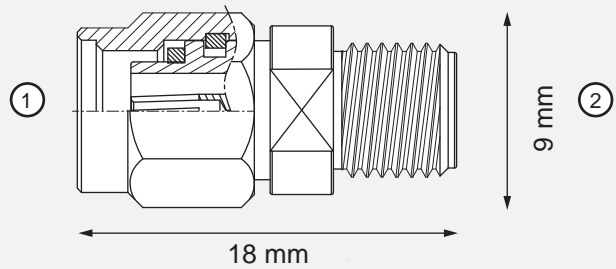

Housing material  
Gold plated brass



Length  
18 mm



diameter  
HEX 8 mm  
max. 9 mm



Impedance  
50 Ω

# Adapter RP-SMA jack > SMA plug

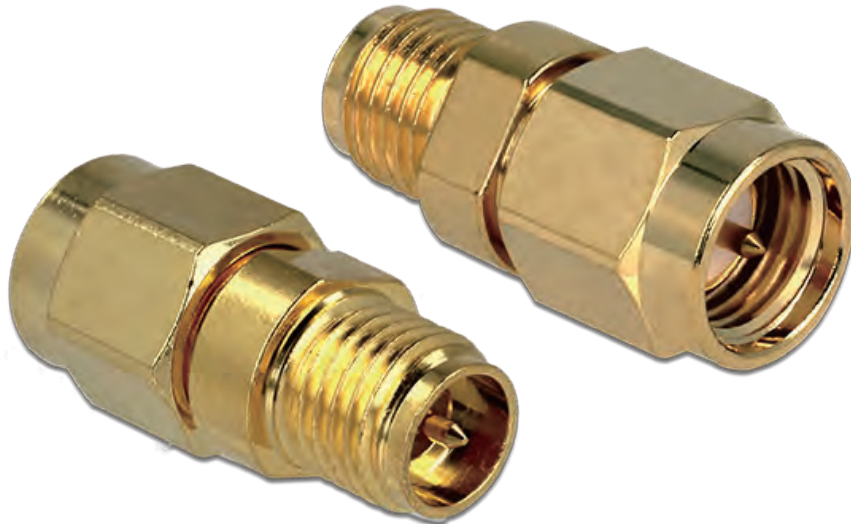

CE

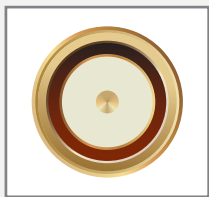

① SMA plug

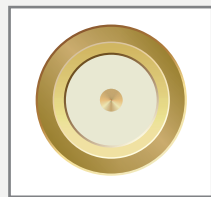

② RP-SMA jack

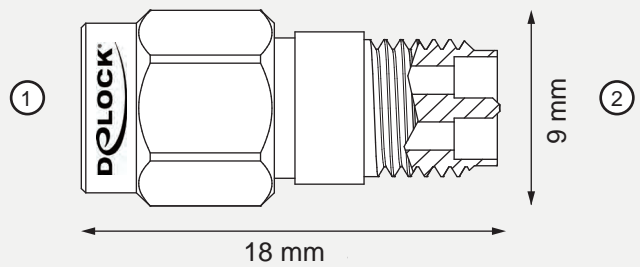

Housing material  
Gold plated brass



Length  
18 mm



diameter  
HEX 8 mm  
max. 9 mm



Impedance  
50 Ω

# Adapter RP-SMA jack > SMA jack



CE

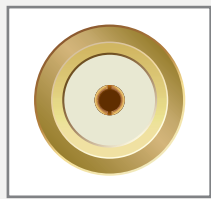

① SMA jack

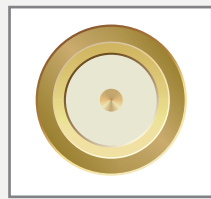

② RP-SMA jack

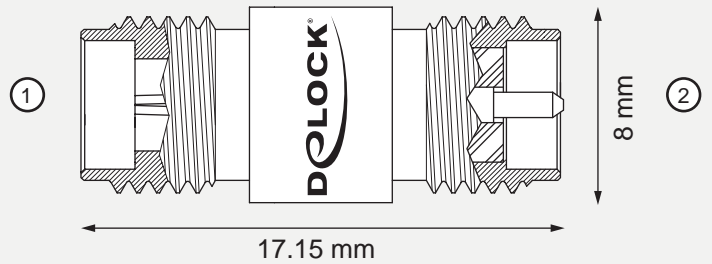

Housing material  
Gold plated brass



Length  
17.15 mm



diameter  
max. 8 mm



Impedance  
50 Ω

# Adapter SMA jack > SMA jack bulkhead

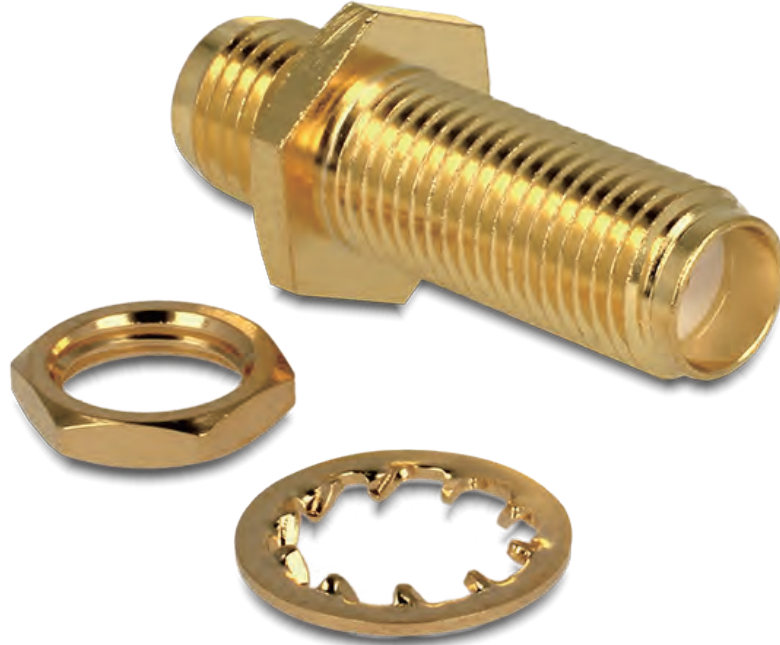

CE

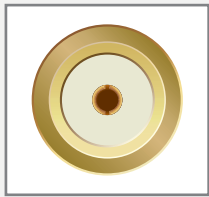

① SMA jack

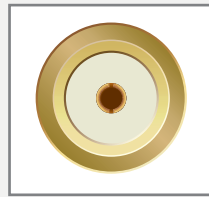

② SMA jack bulkhead

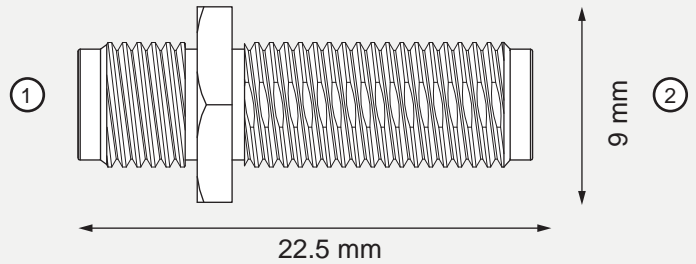

Housing material  
Gold plated brass



Length  
22.5 mm



diameter  
HEX 8 mm  
max. 9 mm



Impedance  
50 Ω

# Adapter N plug > N plug



CE

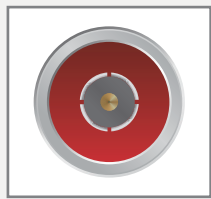

① N plug

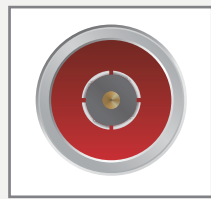

② N plug

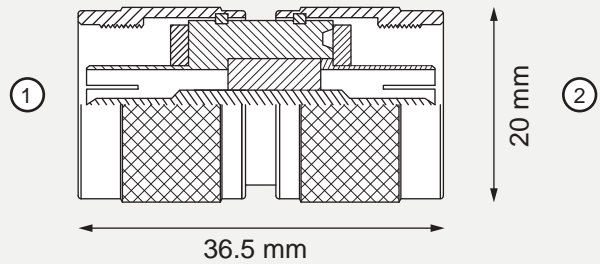

Body  
Nickel plated brass



Pin  
Gold plated brass



Isolator  
PTFE



Length  
36.5 mm



diameter  
20 mm



Impedance  
50 Ω

# Adapter N plug > F jack



CE

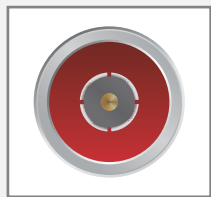

① N plug

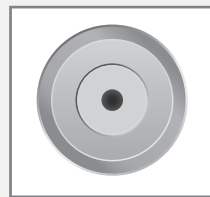

② F jack

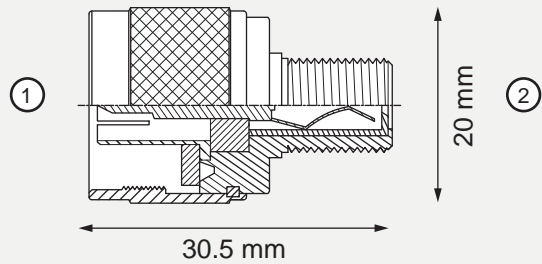

Body  
Nickel plated brass



Pin  
Gold plated brass



Isolator  
delrin



Length  
30.5 mm



diameter  
20 mm



Impedance  
50 Ω

# Adapter N plug > TNC jack



CE

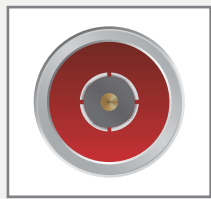

① N plug

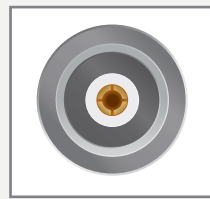

② TNC jack

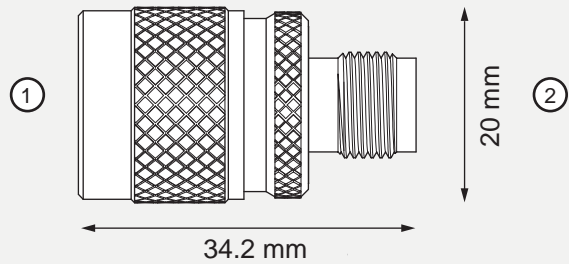

Body  
Nickel plated brass



Pin  
Gold plated brass



Isolator  
delrin



Length  
34.2 mm



diameter  
20 mm



Impedance  
50 Ω



# Adapter N jack > N jack bulkhead



CE

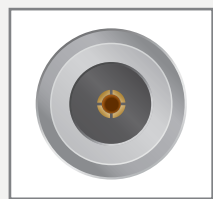

① N jack

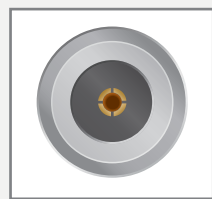

② N jack bulkhead

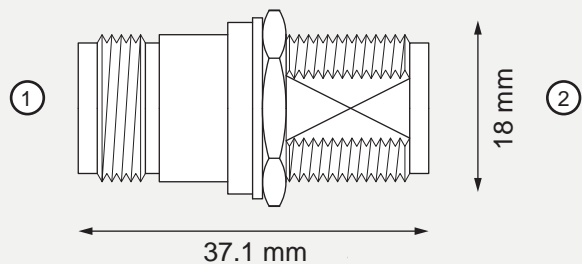

Body  
Nickel plated brass



Pin  
Gold plated brass



Isolator  
PTFE



Length  
37.1 mm



diameter  
max. 18 mm



Impedance  
50 Ω

# Adapter FME plug > SMB plug



CE

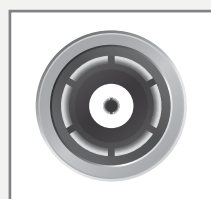

① SMB plug

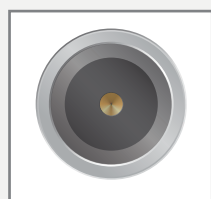

② FME plug

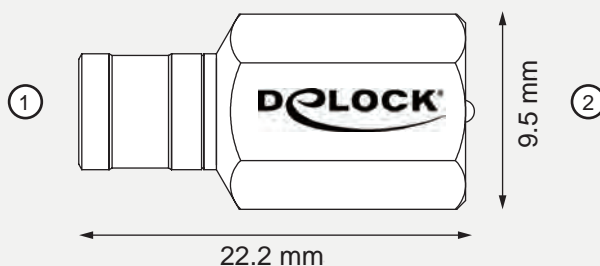

Body  
Nickel plated brass



Pin  
Gold plated  
phosphor bronze



Isolator  
PTFE



Length  
22.2 mm



diameter  
HEX 9.5 mm



Impedance  
50 Ω

# Adapter RP-SMA plug > RP-TNC jack



CE

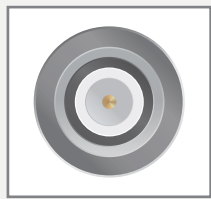

① PR-TNC jack

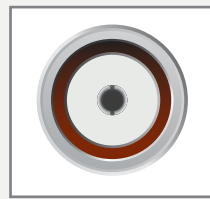

② PR-SMA plug

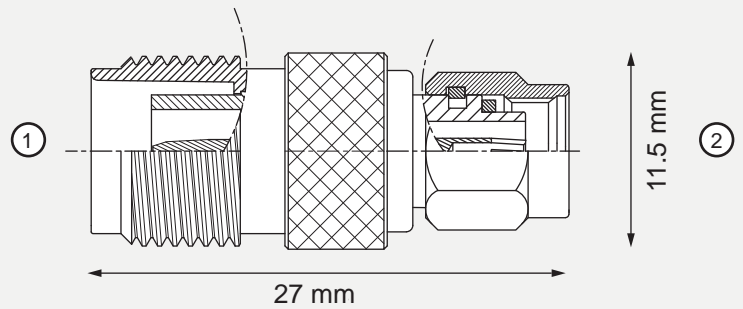

Body  
Nickel plated brass



Pin  
Gold plated brass



Length  
27 mm



Impedance  
50 Ω

# Adapter RP-SMA plug > SMA plug 90°



CE

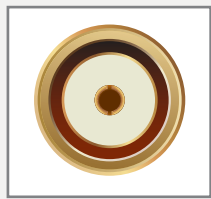

① RP-SMA plug

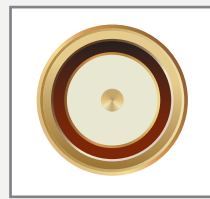

② SMA plug

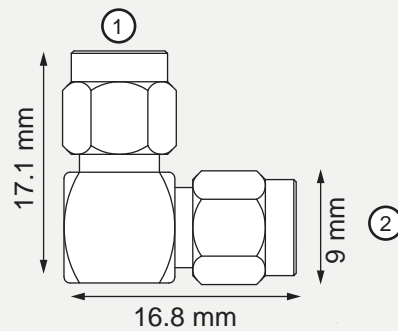

Housing material  
Gold plated brass



Pin  
Gold plated brass



Dimensions  
17.1 x 16.8 mm



diameter  
HEX 8 mm  
max.: 9 mm



Impedance  
50 Ω

# Adapter N plug > TNC plug



CE

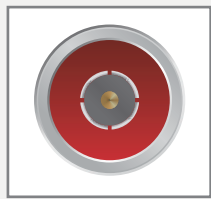

① N plug

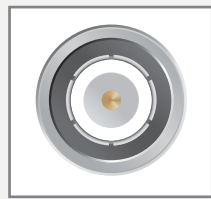

② TNC plug

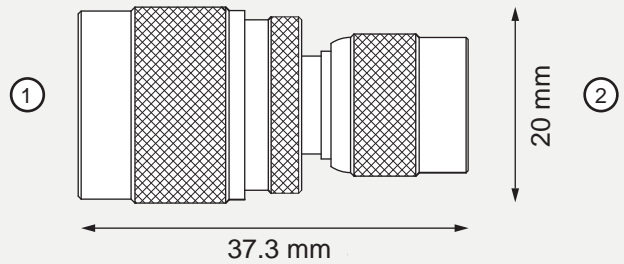

Body  
Nickel plated brass



Pin  
Nickel plated brass



Length  
37.3 mm



diameter  
20 mm



Impedance  
50 Ω

# Adapter SMA jack > SMB jack



CE

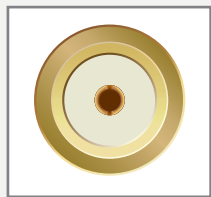

① SMA jack

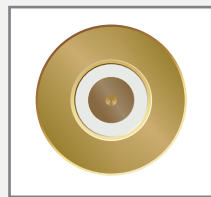

② SMB jack

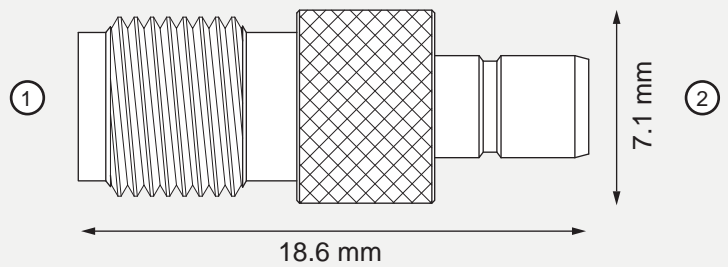

Body  
Gold plated brass



Pin  
Gold plated brass



Length  
18.6 mm



diameter  
7.1 mm



Impedance  
50 Ω

# Adapter SMA jack > SMB plug



CE

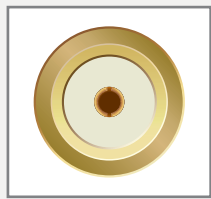

① SMA jack

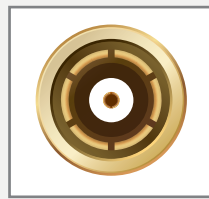

② SMB plug

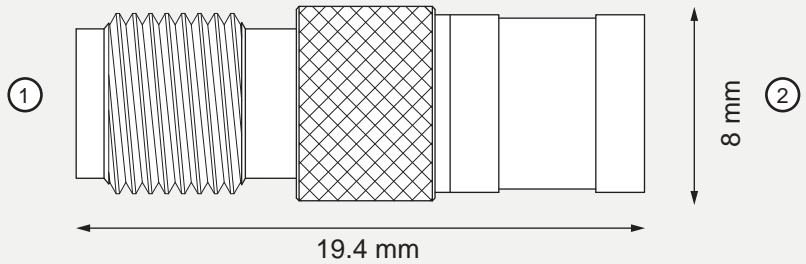

Body  
Gold plated brass



Pin  
Gold plated brass



Length  
19.4 mm



diameter  
8 mm



Impedance  
50 Ω

# Adapter SMA plug > SMB jack



CE

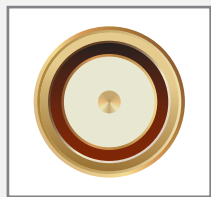

① SMA plug

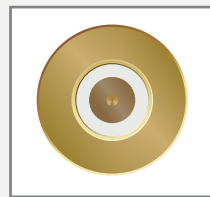

② SMB jack

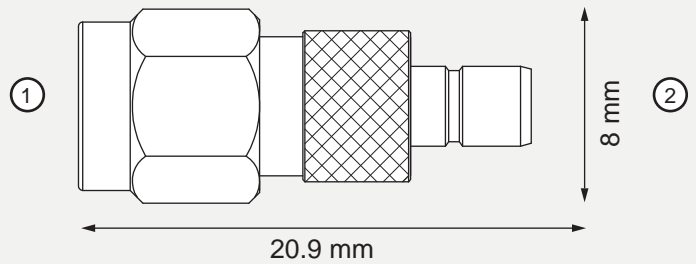

Body  
Gold plated brass



Pin  
Gold plated brass



Length  
20.9 mm



diameter  
8 mm



Impedance  
50 Ω



# Adapter N plug > SMA plug



CE

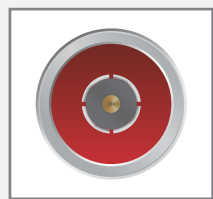

① N plug

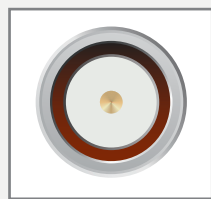

② SMA plug

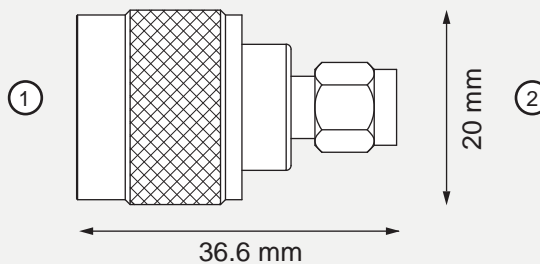

Body  
Nickel plated brass



Pin  
Nickel plated brass



Length  
36.6 mm



diameter  
20 mm



Impedance  
50 Ω

# Adapter N jack > SMA jack



CE

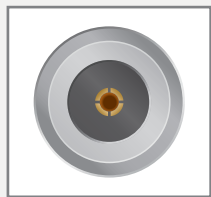

① N jack

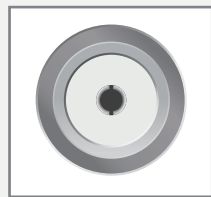

② SMA jack

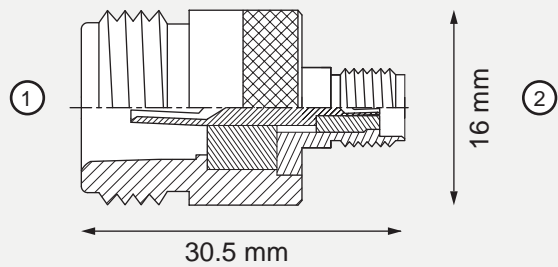

Body  
Nickel plated brass



Pin  
Nickel plated brass



Length  
30.5 mm



diameter  
16 mm



Impedance  
50 Ω

# Adapter N jack > SMA plug



CE

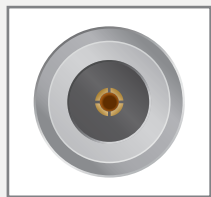

① N jack

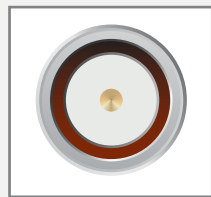

② SMA plug

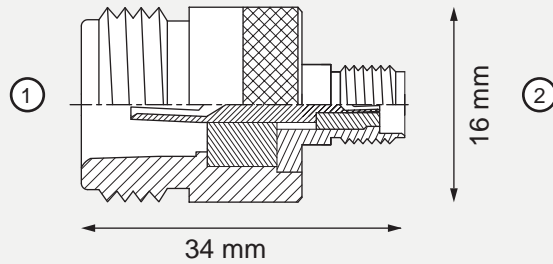

Body  
Nickel plated brass  
Gold plated brass



Pin  
Nickel plated brass  
Gold plated brass



Length  
34 mm



diameter  
16 mm



Impedance  
50 Ω

# Adapter N plug > SMA jack



CE

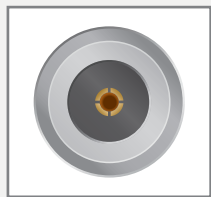

① N jack

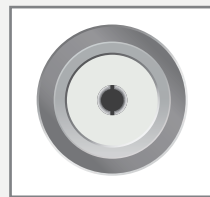

② SMA jack

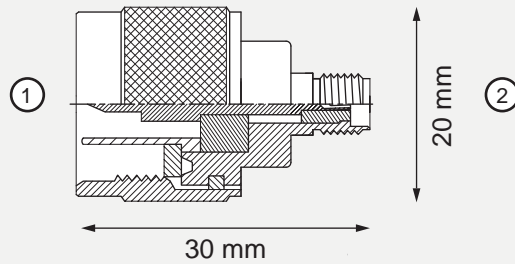

Body  
Nickel plated brass



Pin  
Nickel plated brass



Length  
30 mm



diameter  
20 mm



Impedance  
50 Ω

# Adapter N jack > BNC jack bulkhead



CE

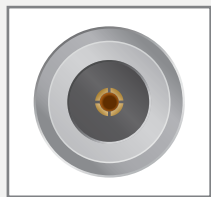

① N jack

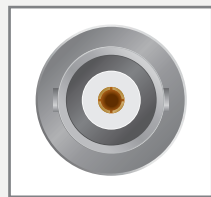

② BNC jack bulkhead

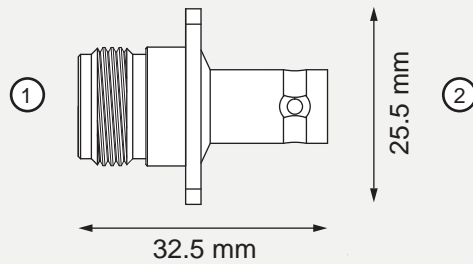

Body  
Nickel plated brass



Pin  
Gold plated brass



Length  
32.5 mm



Mounting diameter  
15.6 mm



Mounting plate  
25.5 x 25.5 mm



Impedance  
50 Ω

# Adapter N plug > 7/16 jack



CE

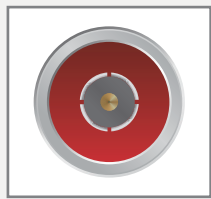

① N plug

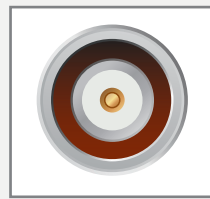

② 7/16 jack

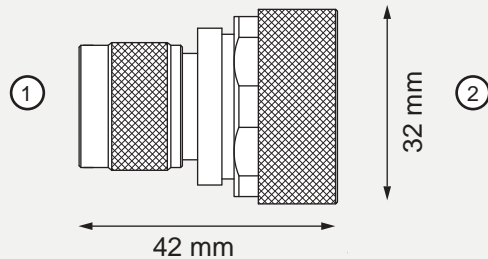

Body  
Nickel plated brass



Pin  
Nickel plated brass



Length  
42 mm



diameter  
32 mm



Impedance  
50 Ω

# Adapter N jack > BNC jack



CE

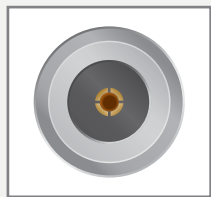

① N jack

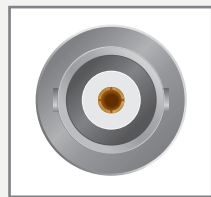

② BNC jack

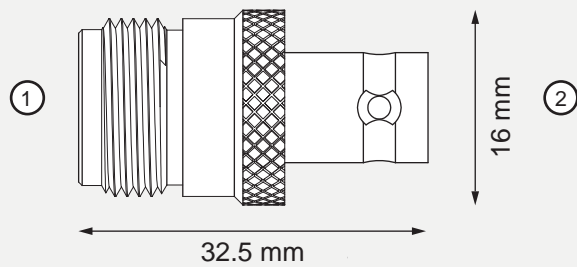

Body  
Nickel plated brass



Pin  
Nickel plated brass



Length  
32.5 mm



diameter  
16 mm



Impedance  
50 Ω

# Adapter N jack > RP-SMA plug bulkhead



CE

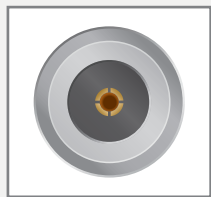

① N jack

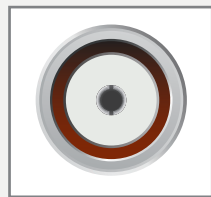

② RP-SMA plug bulkhead

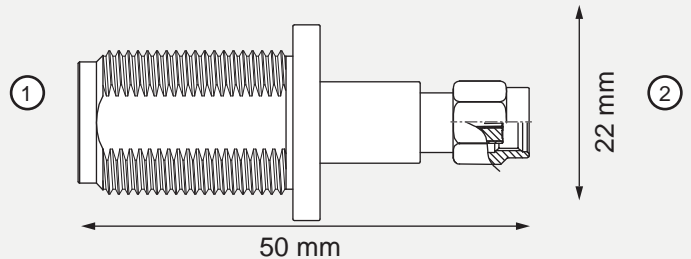

Body  
Nickel plated brass



Pin  
Nickel plated brass



Length  
50 mm



diameter  
22 mm



Impedance  
50 Ω



# Adapter N jack > RP-SMA plug



CE

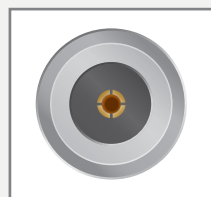

① N jack

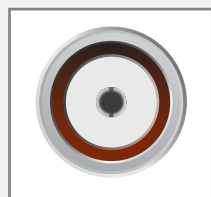

② RP-SMA plug

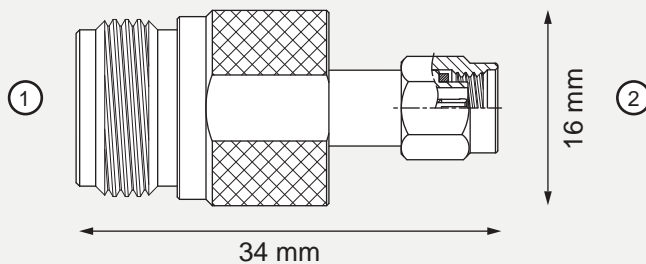

Body  
Nickel plated brass



Pin  
Nickel plated brass  
Gold plated brass



Length  
34 mm



diameter  
16 mm



Impedance  
50 Ω

# Adapter N plug > RP-SMA jack



CE

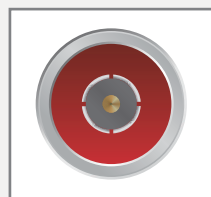

① N plug

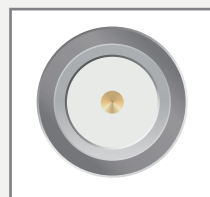

② RP-SMA jack

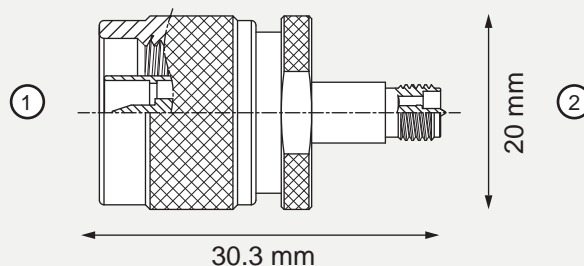

Body  
Nickel plated brass



Length  
30.3 mm



diameter  
20 mm



Impedance  
50 Ω

# Adapter RP-TNC jack > SMA jack



CE

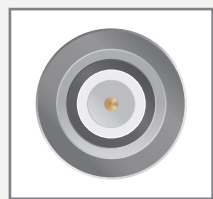

① RP-TNC jack

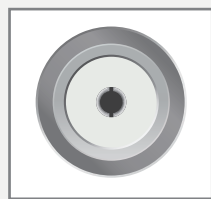

② SMA jack

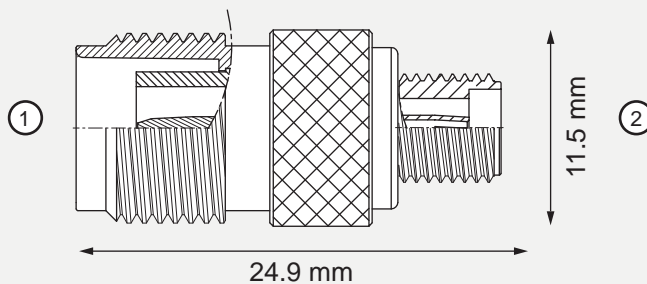

Body  
Nickel plated brass



Pin  
Gold plated brass



Length  
24.9 mm



diameter  
11.5 mm



Impedance  
50 Ω

# Adapter RP-TNC plug > SMA plug



CE

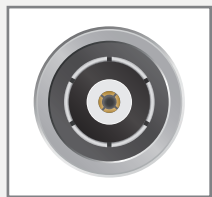

① RP-TNC plug

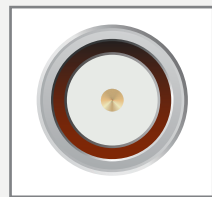

② SMA plug

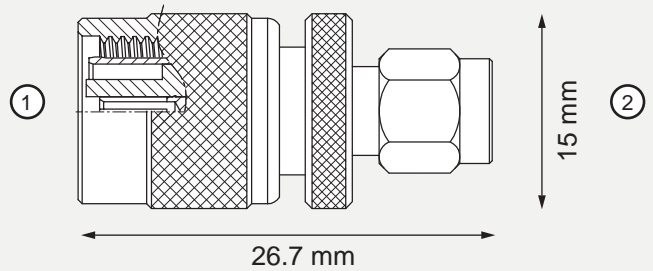

Body  
Nickel plated brass



Pin  
Gold plated brass



Length  
26.7 mm



diameter  
15 mm



Impedance  
50 Ω

# Adapter N plug > RP-TNC jack



CE

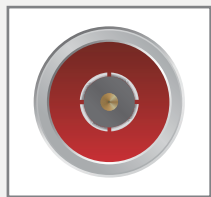

① N plug

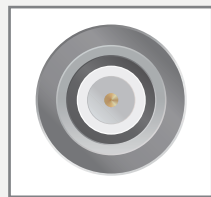

② RP-TNC jack

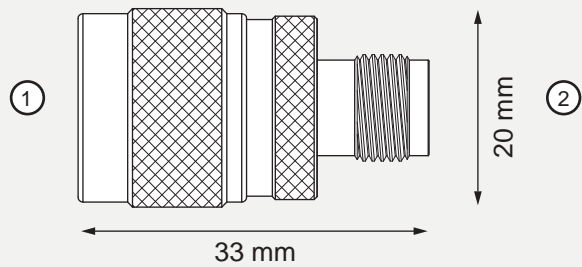

Body  
Nickel plated brass



Length  
33 mm



diameter  
20 mm



Impedance  
50 Ω

# Adapter N jack > RP-TNC plug



CE

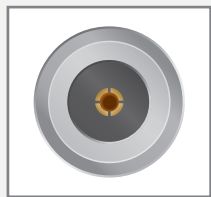

① N jack

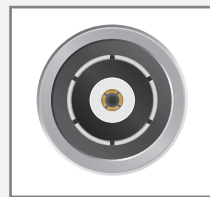

② RP-TNC plug

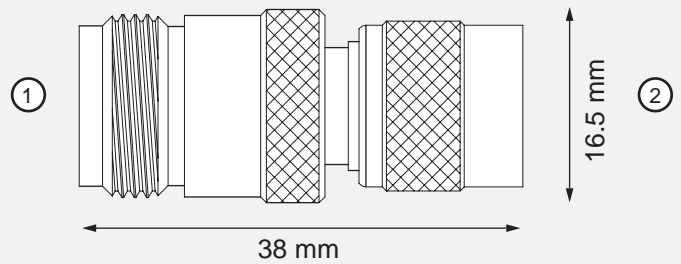

Body  
Nickel plated brass



Length  
38 mm



diameter  
16.5 mm



Impedance  
50 Ω

# Adapter N jack > RP-TNC jack



CE

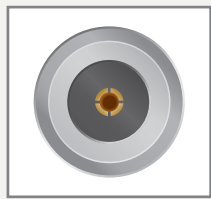

① N jack

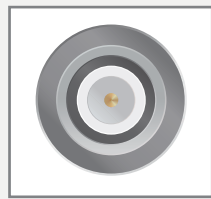

② RP-TNC jack

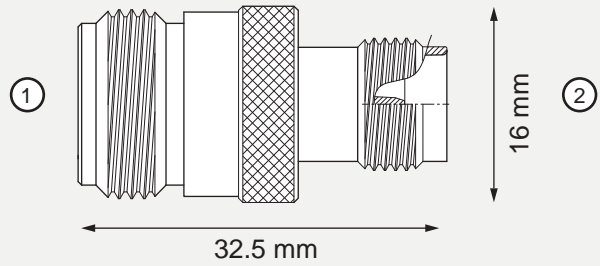

Body  
Nickel plated brass



Length  
32.5 mm



diameter  
16 mm



Impedance  
50 Ω

# Adapter N plug > RP-TNC plug



CE

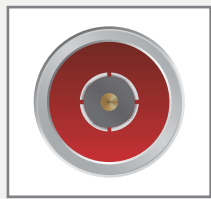

① N plug

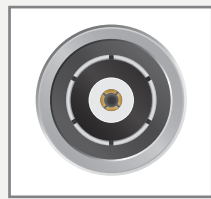

② RP-TNC plug

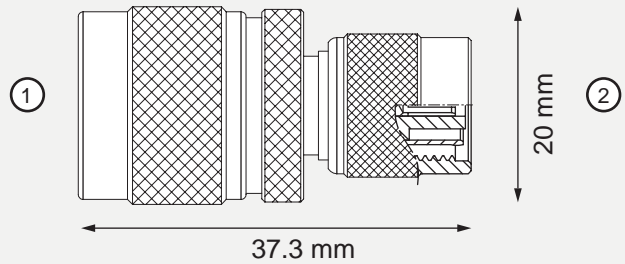

Body  
Nickel plated brass



Length  
37.3 mm



diameter  
20 mm



Impedance  
50 Ω



# Adapter MCX plug > N plug



CE

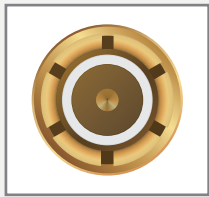

① MCX plug

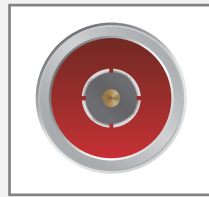

② N plug

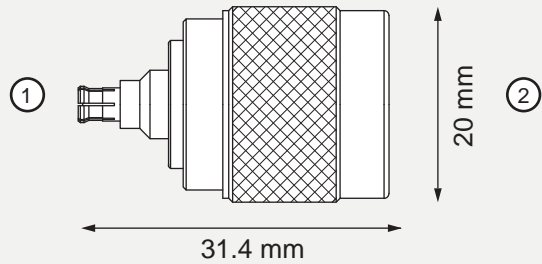

Body  
Nickel plated brass



Length  
31.4 mm



diameter  
20 mm



Impedance  
50 Ω

# Adapter N jack > SMB jack



CE

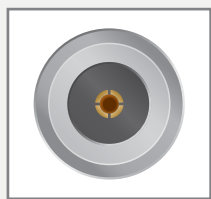

① N jack

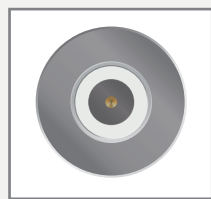

② SMB jack

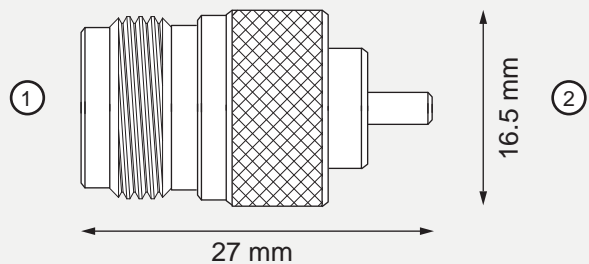

Body  
Nickel plated brass



Pin  
Nickel plated brass



Length  
27 mm



diameter  
16.5 mm



Impedance  
50 Ω

# Adapter N plug > SMB plug



CE

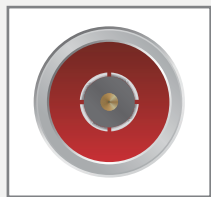

① N plug

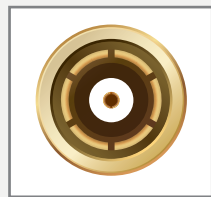

② SMB plug

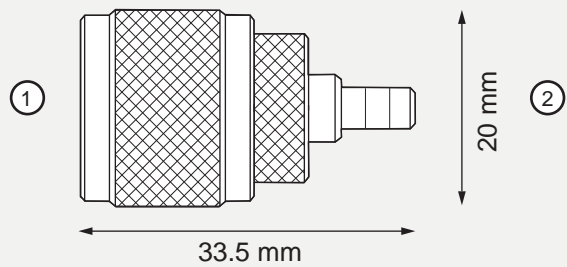

Body  
Nickel plated brass



Pin  
Nickel plated brass



Length  
33.5 mm



diameter  
20 mm



Impedance  
50 Ω

# Adapter N jack > SMB plug



CE

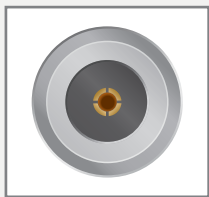

① N jack

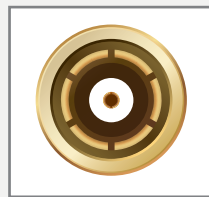

② SMB plug

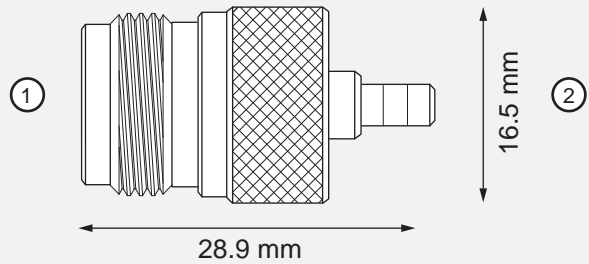

Body  
Nickel plated brass



Pin  
Nickel plated brass



Length  
28.9 mm



diameter  
16.5 mm



Impedance  
50 Ω

# Adapter N plug > SMB jack



CE

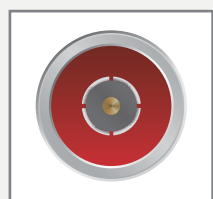

① N plug

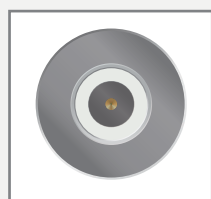

② SMB jack

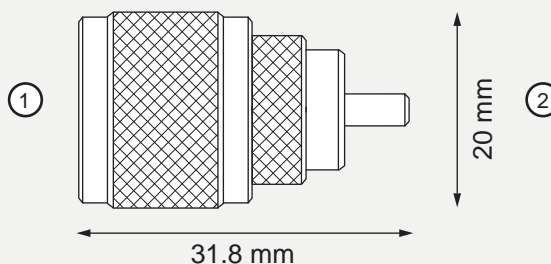

Body  
Nickel plated brass



Pin  
Nickel plated brass



Length  
31.8 mm



diameter  
20 mm



Impedance  
50 Ω

# Adapter N jack > SMA jack bulkhead



CE

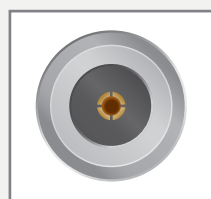

① N jack

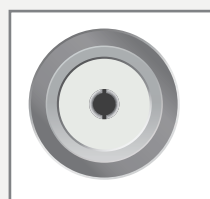

② SMA jack bulkhead

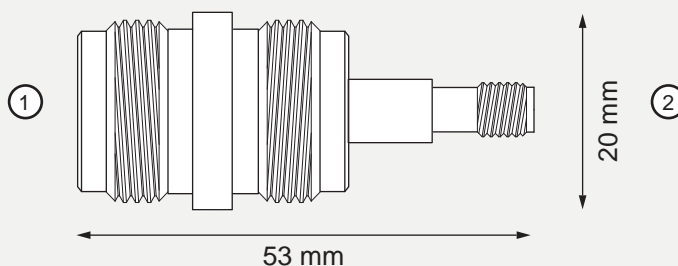

Body  
Nickel plated brass



Pin  
Nickel plated brass



Length  
53 mm



diameter  
20 mm



Impedance  
50 Ω

# Adapter RP-SMA plug metric thread > RP-SMA jack



CE

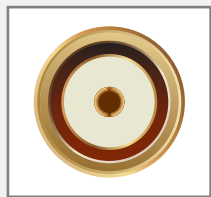

① RP-SMA plug

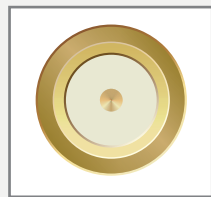

② RP-SMA jack

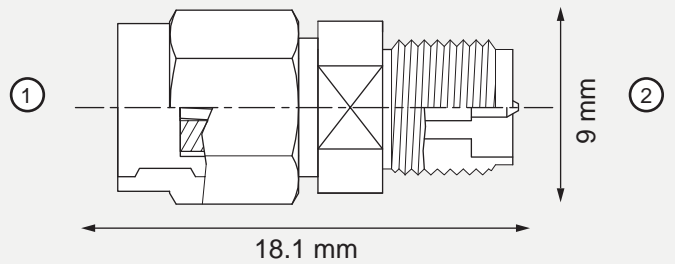

Body  
Gold plated brass



Length  
18.1 mm



diameter  
9 mm



Impedance  
50 Ω

# Adapter F jack > F plug 90°

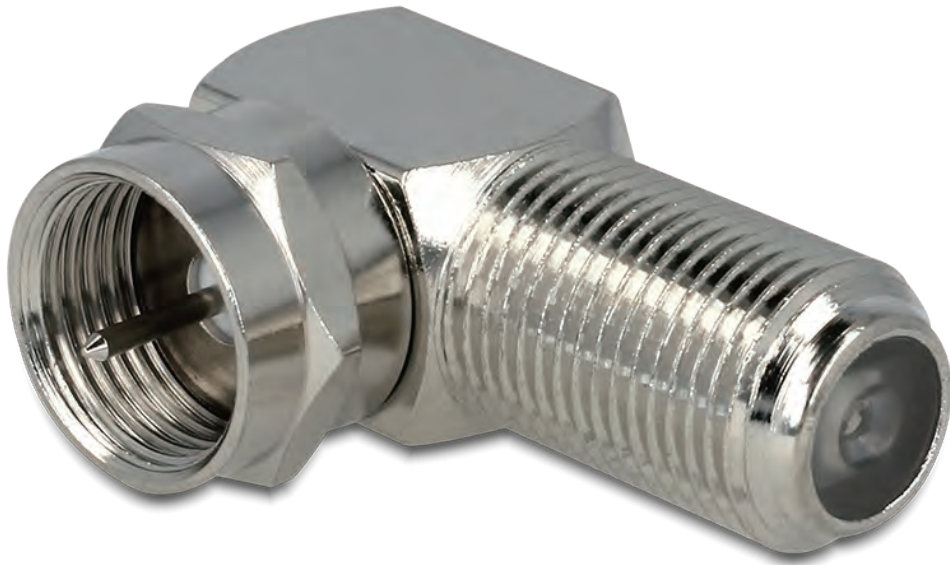

CE

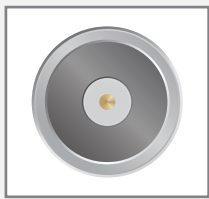

① F plug

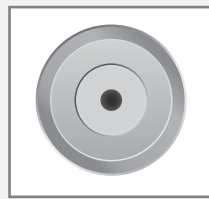

② F jack

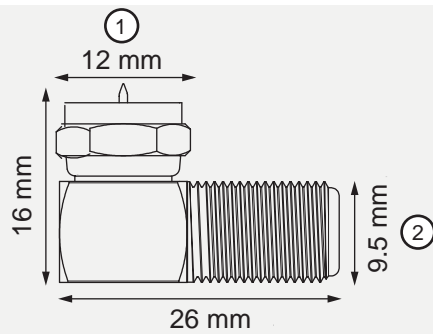

Angled 90°



Housing material  
Nickle plated brass



Length  
26 x 16 mm



diameter  
HEX 11 mm  
max. 12mm



Impedance  
75 Ω



# Adapter F jack > F jack > F jack T-Shape

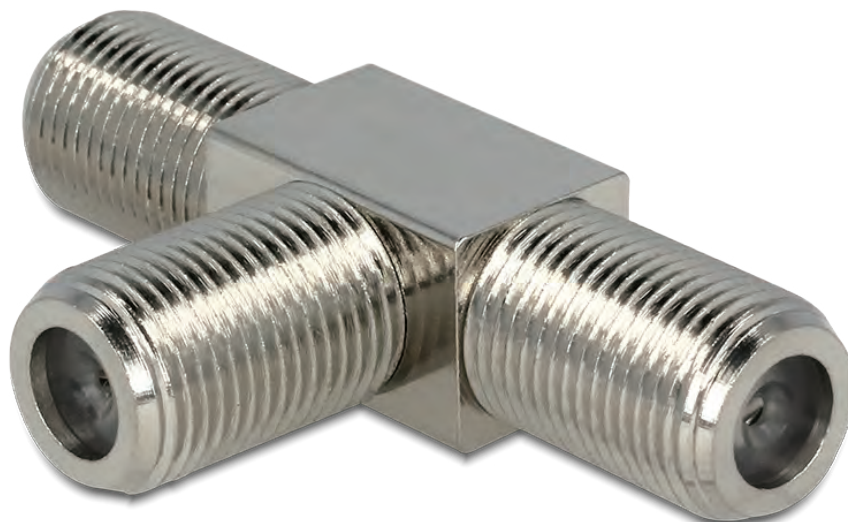

CE

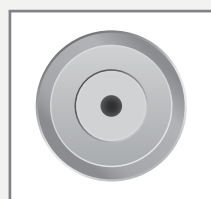

① F jack

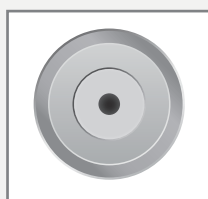

② F jack

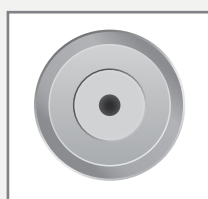

② F jack

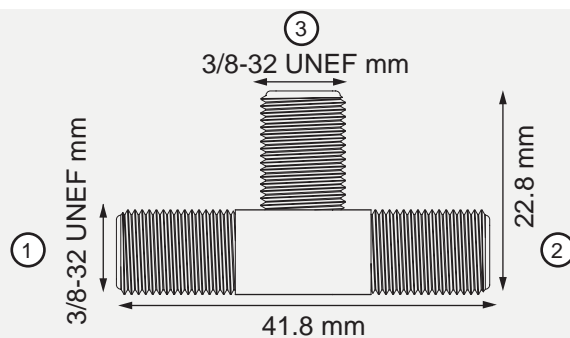

T-shape



Housing material  
Nickle plated brass



Length  
41.8 x 22.8 mm



diameter  
3/8-32 UNEF



Impedance  
75 Ω

# Adapter F jack > F jack



CE

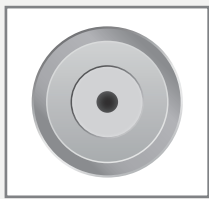

① F jack

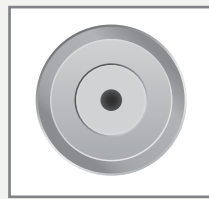

② F jack

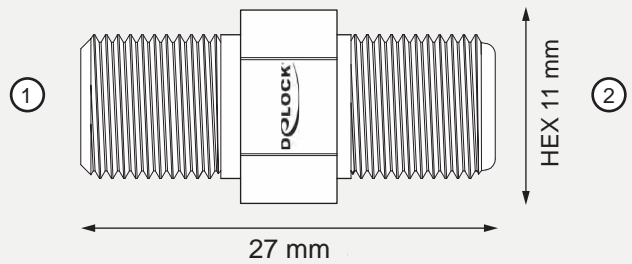

Housing material  
Nickel plated brass



Length  
27 mm



diameter  
HEX 11 mm



Impedance  
75 Ω

# Adapter F plug > F plug



CE

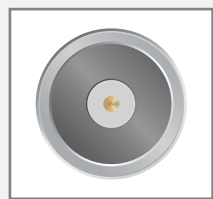

① F plug

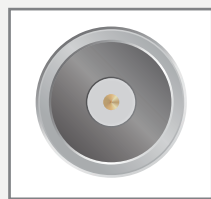

② F plug

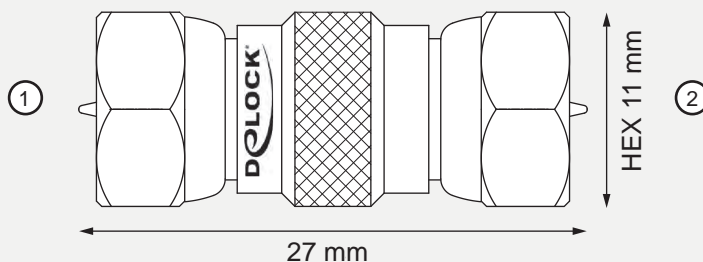

Housing material  
Nickle plated brass



Length  
27 mm



diameter  
HEX 11 mm



Impedance  
75 Ω

# Adapter SMA plug > SMA plug 90°



CE



① SMA plug

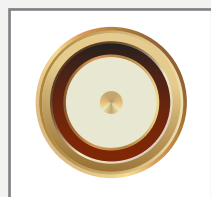

② SMA plug

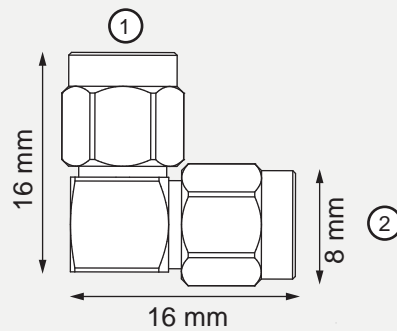

Angled  
90°



Housing material  
Gold plated brass



Length  
16 x 16 mm



diameter  
8 mm



Impedance  
50 Ω

# Adapter SMA jack > SMA jack > SMA jack T-Shape

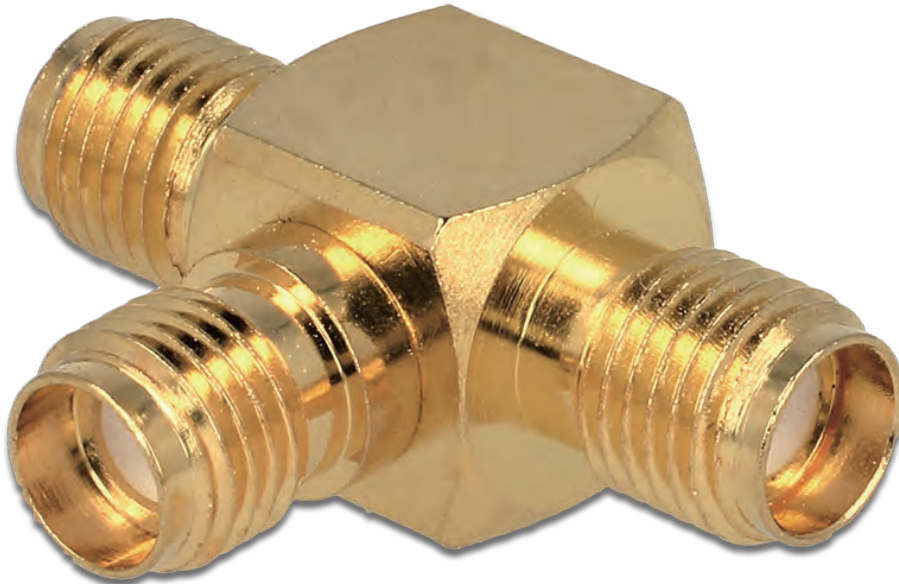

CE

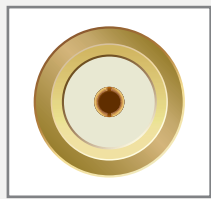

① SMA jack

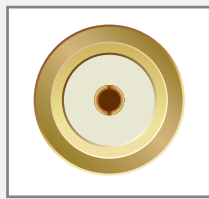

② SMA jack

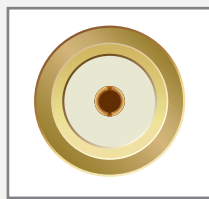

② SMA jack

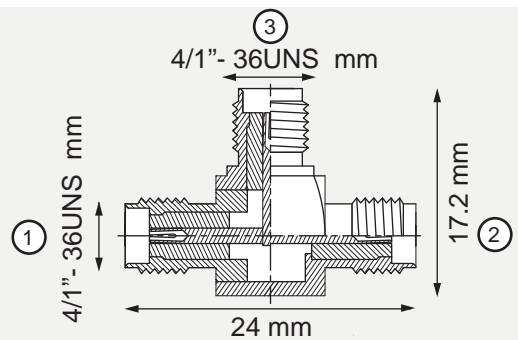

T-shape



Housing material  
Gold plated brass



Dimensions  
24 x 17.2 x 9.1 mm



diameter  
3/8-32 UNEF



Impedance  
50 Ω

# Adapter N jack > TNC plug



CE

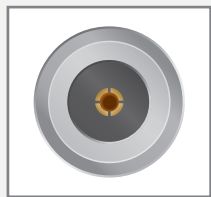

① N jack

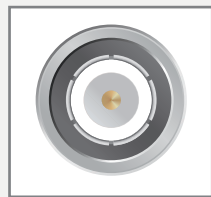

② TNC plug

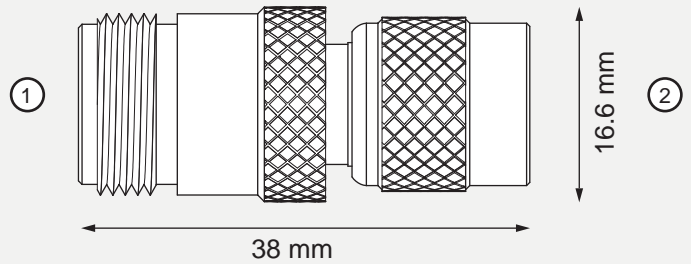

Body  
Nickel plated brass



Pin  
Gold plated brass



Length  
38 mm



diameter  
16.6 mm



Impedance  
50 Ω